



## **LT-3100 IRIDIUM COMMUNICATIONS SYSTEM**

designed and built for the demanding and rough environment at sea

## LT-3100 IN SHORT

- Voice, SMS, Data, and Vessel tracking
- 2.4 Kbit/s and 10 Kbit/s compressed data
- Programmable softkeys for e.g. Emergency Service
- Single antenna cable solution (up to 500 m)
- High-performance GNSS/GPS receiver
- Noise-canceling microphone and equalizer for improved audio quality
- Bluetooth interface supporting voice, SMS, and data

- Large 4.3" TFT display supporting day and night modes
- Voice prompt audio feedback
- Firewall and user authentication for high level of security
- Webserver for configuration and maintenance
- Support external LAN Wi-Fi Access Points
- Support external SIP PABX and SIP handsets
- Connectivity of Smartphones, Softphones, and Apps

## PRODUCT DESCRIPTION

The LT-3100 Iridium Communications System is a maritime satellite communication product from Lars Thrane A/S. The LT-3100 system is designed for the professional market (deep sea, fishing, and work-boats), but can be used for the leisure market as well. The LT-3100 system meets all standards and certification requirements needed for worldwide maritime satellite communication equipment.

The LT-3100 system has voice and data capabilities with 100% global coverage. The LT-3100 system consist of a control unit, handset unit, and antenna unit. A single cable coaxial connects the control unit with the antenna unit. Using a standard coaxial cable, up to 500 meters of separation between the units can be obtained, giving freedom to mount the antenna in the best possible location, with free line of sight to the satellites.

The LT-3100 system can be used as the primary satellite communication product on vessels, covering the basic communication needs in terms of connectivity between the ship and shore. In addition, the LT-3100 system can be used for crew calling or as a back-up satellite communication product. The LT-3100 system provides voice, SMS, data, vessel tracking, and other Iridium services with competitive airtime rates, making it the perfect satellite communication product on board any vessel.

### 100% GLOBAL COVERAGE



## PRODUCT FEATURES

### VOLUME CONTROL

Speaker and ringer volume control button

### RINGER

Incoming call ringer

### NOISE-CANCELING

Active noise-canceling microphone. Improving voice quality in noisy environments

### COLOR DISPLAY

Large 4.3" TFT display supporting brightness adjustment and day/night mode themes

### KEYPAD

Responsive keypad with brightness adjustment

### AUDIO SPEAKER

Audio speaker supporting key beep, voice prompt, and alarms

### FUNCTIONAL KEYS

Functional keys; off-hook, on-hook, navigation keys, and programmable softkeys

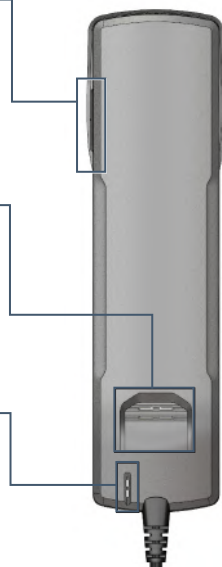

## INTERFACES

### ETHERNET

Ethernet LAN (RJ45). Connectivity for data, voice (SIP), service and maintenance

### CHASSIS GROUND

Chassis ground connector

### ANTENNA

Coaxial type-N connector. One cable solution supporting power and communication to the antenna

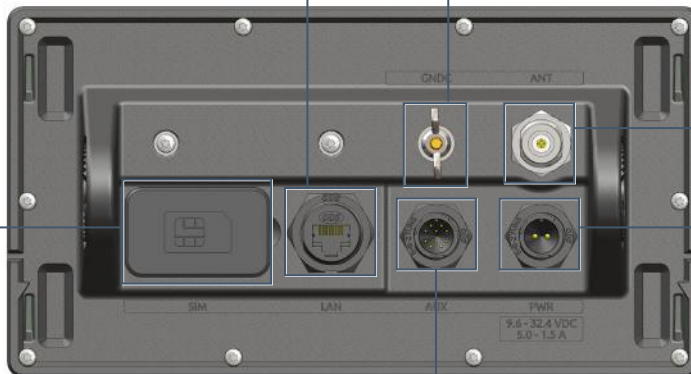

### SIM CARD

SIM card behind rubber dust cover for easy insertion and replacement

### AUXILIARY

Auxiliary (10-pin) supporting RS-422, radio silence, and external ringer

### POWER

DC power 9.6 - 32.4 VDC (5.0 - 1.5 A)

## INSTALLATION OPTIONS

### ANTENNA MOUNTING KITS



Antenna pole mount (1.5" tube)



Antenna angle bracket mount (1" to 2.5" tube)

### CONTROL UNIT MOUNTING KITS



Control unit bracket mount



Control unit flush mount

## SYSTEM CONFIGURATION

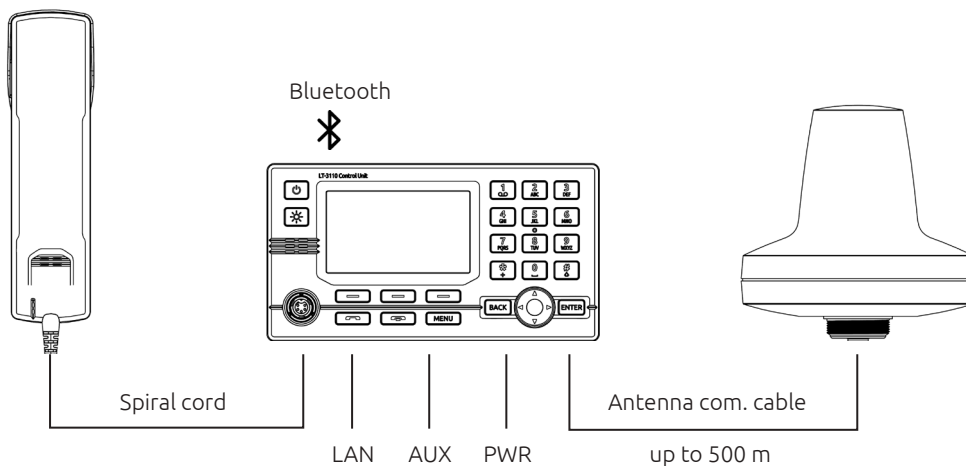

# SPECIFICATIONS

## LT-3100 IRIDIUM COMMUNICATIONS SYSTEM

Certification & standards	CE, IEC 60945, IEC 60950, EN 300 440 FCC, IC, RoHS, Iridium Communication Inc.
Vibration, operational	IEC 60945 (sine) & Proprietary Maritime Random profile (240 h)
Vibration, survival	Proprietary Maritime Random profile (100 h)
Vibration, shock	Proprietary Maritime profile (20 g, 11 ms)

### LT-3110 Control Unit

Weight	698 g (1.54 lbs)
Dimensions	224.0 x 120.0 x 70.0 mm (8.82 x 4.72 x 2.76 in)
Temperature, operational	-15°C to +55°C (+5°F to +131°F)
IP rating, dust and water	IP42 (front) / IP40 (back)
Interfaces	Ethernet, auxiliary, power, chassis ground, antenna, handset, Bluetooth, SIM card
Input voltage	9.6-32.4 VDC
Power consumption	< 50 W
Compass safe distance, std. and steer.	0.3 m (1 ft)

### LT-3120 Handset Unit

Weight	295 g (0.65 lbs)
Dimensions	209.0 x 54.0 x 38.0 mm (8.23 x 2.13 x 1.50 in)
Temperature, operational	-15°C to +55°C (+5°F to +131°F)
IP rating, dust and water	IP30
Compass safe distance, std. and steer.	0.3 m (1 ft)

### LT-3130 Antenna Unit

Weight	882 g (1.94 lbs)
Dimensions	151.0 x Ø 149.0 mm (5.94 x Ø 5.87 in)
Temperature, operational	-25°C to +55°C (-13°F to +131°F)
IP rating, dust and water	IP67
Compass safe distance, std. and steer.	0.3 m (1 ft)

Antenna communication cable	up to 500 m (1500 ft)
Warranty	2 year
Maintenance	None

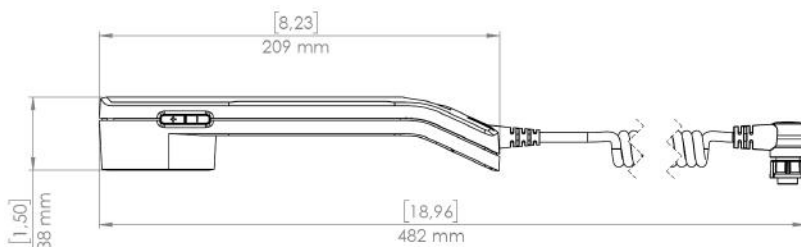
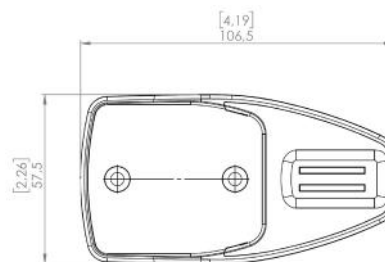
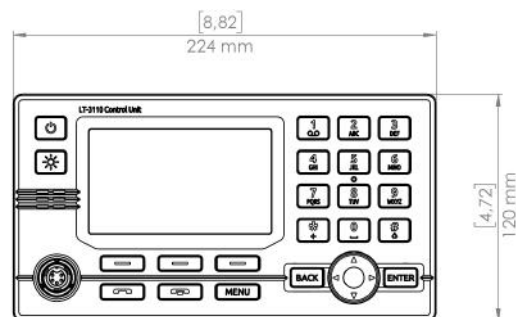
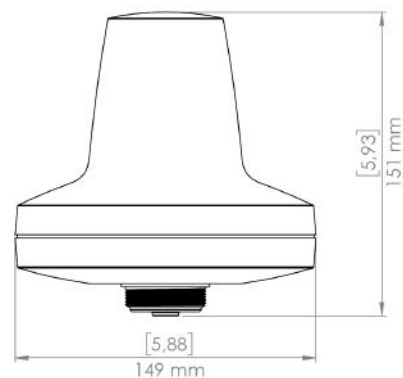

## IN THE BOX

LT-3110 Control Unit	P/N: 51-100987
LT-3120 Handset Unit and Cradle	P/N: 51-100988
LT-3130 Antenna Unit	P/N: 51-100989
Control Unit Bracket Mount	P/N: 91-100771
3m DC Power Cable	P/N: 91-100767
Quick Installation Guide	P/N: 97-100765
Unit Test Sheet	P/N: 46-100729

## ACCESSORIES

Control Unit Flush Mount	P/N: 91-100772
Antenna Angle Bracket Mount (1" to 2.5" tube)	P/N: 91-100773
Antenna Pole Mount (1.5" tube)	P/N: 91-100774
3m Auxiliary Cable	P/N: 91-100768
10m Coaxial Cable	P/N: 91-101137
25m Coaxial Cable	P/N: 91-101138
50m Coaxial Cable	P/N: 91-101140



Lars Thrane A/S  
Stubbeled 2  
DK- 2950 Vedbæk, Denmark  
Phone: +45 88 30 10 00 Fax: +45 88 30 10 09  
Email: [company@thrane.eu](mailto:company@thrane.eu)  
CVR DK-36042443  
[www.thrane.eu](http://www.thrane.eu)

