

SAILOR 6390 Navtex Receiver

User manual

Document number: 98-137261-A

Release date: October 16, 2013

Disclaimer

Any responsibility or liability for loss or damage in connection with the use of this product and the accompanying documentation is disclaimed by Thrane & Thrane A/S. The information in this manual is provided for information purposes only, is subject to change without notice and may contain errors or inaccuracies. Manuals issued by Thrane & Thrane A/S are periodically revised and updated. Anyone relying on this information should acquire the most current version e.g. from www.cobham.com/satcom or from the distributor. Thrane & Thrane A/S is not responsible for the content or accuracy of any translations or reproductions, in whole or in part, of this manual from any other source.

Thrane & Thrane A/S is trading as Cobham SATCOM.

Copyright

© 2013 Thrane & Thrane A/S. All rights reserved.

Trademark Acknowledgements

- SAILOR is a registered trademark of Thrane & Thrane A/S in the European Union and the United States of America and other countries.
- Other product and company names mentioned in this manual may be trademarks or trade names of their respective owners.
- This product contains Android™ software. Android is a trademark of Google Inc.

GPL notification

The software included in this product contains copyrighted software that is licensed under the GPL/LGPL. The verbatim licenses can be found online at:

<http://www.gnu.org/licenses/old-licenses/gpl-2.0.html>

<http://www.gnu.org/licenses/old-licenses/lgpl-2.1.html>

You may obtain the complete corresponding source code from us for a period of three years after our last shipment of this product, which will be no earlier than 2021, by sending a money order or check for DKK 50 to:

SW Technology/GPL Compliance,

Thrane & Thrane A/S,

Lundtoftegaardsvej 93D

2800 Lyngby

DENMARK

Please write "source for product SAILOR 6390 Navtex Receiver" in the memo line of your payment. This offer is valid to anyone in receipt of this information.

Safety summary

Observe the following general safety precautions during all phases of operation, service and repair of this equipment. Failure to comply with these precautions or with specific warnings elsewhere in this manual violates safety standards of design, manufacture and intended use of the equipment. Thrane & Thrane A/S assumes no liability for the customer's failure to comply with these requirements.

Ground the equipment

To minimise shock hazard, connect the SAILOR 6390 Navtex Receiver to an electrical ground and follow the cable instructions.

Warranty limitation

The SAILOR 6390 Navtex Receiver is not a user maintainable unit, and under no circumstances should the unit be opened beyond the outer plastic cover, except by authorized personnel. Unauthorized opening of the unit will invalidate the warranty.

Installation and service

Installation and general service must be done by skilled service personnel. The SAILOR 6390 Navtex Receiver is intended for use in a protected environment (-15° to +55°C) according to IEC-60945.

Compass safe distance

Compass safe distance: 20 cm (Standard magnetic compass), 20 cm (Emergency magnetic compass) from the SAILOR 6390 Navtex Receiver.

Preface

Approvals and standard compliance

SAILOR 6390 Navtex Receiver is approved to MED 2012/32/EU and fulfills the requirements in the following standards:

IEC-60945 (2002), IEC-60945 Corrigendum 1 (2008), IEC-61097-6 (2005-12), IEC-61162-1 (2010-11) (aligned with NMEA 0183 version 4.00), ITU-T X.27/V.11 (1996)

The SAILOR 6390 Navtex Receiver is approved to SOLAS Regulations IV/7, IV/14: ITU-R M.540-2 (06/90) and ITU-R M.625-3 (10/95).

The SAILOR 6390 Navtex Receiver is approved to FCC Equipment class: RNV, Part 80 NAVTEX Receiver 80.1101(c)(1).

The approvals of the SAILOR 6390 Navtex Receiver are constantly monitored. New national approvals will be applied for and granted and new test standards may come into force.

Therefore the above list may not be complete. Contact your authorized dealer for more information.

About the manual

Intended readers

This manual is a user manual for the SAILOR 6390 Navtex Receiver system. This manual is intended for anyone who is using or intends to use this system. No specific skills are required to operate the SAILOR 6390 Navtex Receiver. However, it is important that you observe all safety requirements listed in the beginning of this manual, and operate the system according to the guidelines in this manual.

Note that this manual does not cover installation of the system. For information on installation refer to the installation manual. Part numbers for related manuals are listed in the next section.

Related documents

The following table shows the documents related to this manual and to the SAILOR 6390 Navtex Receiver.

Title and description	Document number
SAILOR 6390 Navtex Receiver, Installation manual	98-139768
SAILOR 6004 Control Panel, Installation manual	98-136644
SAILOR 6390 Navtex Receiver, Installation guide	98-137263

Typography

In this manual, typography is used as indicated below:

Bold is used for the following purposes:

- To emphasize words.
Example: “Do **not** touch the antenna”.
- To indicate what the user should select in the user interface.
Example: “Select **Settings**”.

Italic is used to emphasize the paragraph title in cross-references.

Example: “For further information, see *Connecting Cables* on page...”.

Table of contents

Chapter 1	Introduction	
	SAILOR 6390 Navtex Receiver	1
	Navtex message (example)	3
	Use scenarios	4
Chapter 2	Operation	
	Operation – SAILOR 6004 Control Panel	5
	Operation with INS equipment	12
Chapter 3	Service & maintenance	
	Maintenance	13
	Alarms and notifications	15
	Reinstalling or updating the Navtex app	17
	Troubleshooting guide	22
	Service and repair	24
App. A	Specifications	
	SAILOR 6390 Navtex Receiver	27
Glossary	29
Index	31

Introduction

SAILOR 6390 Navtex Receiver

The SAILOR 6390 Navtex Receiver receives Navtex messages on the international Navtex frequencies 490 kHz, 518 kHz and 4,209.5 kHz. It can hold 2000 messages per frequency. Messages are not affected by a power cycle. If not tagged to avoid deletion, messages are cleared from the message log after 66¹ hours. You can customise which stations to receive messages from and which message types you want to receive. The unit has an alarm relay which is only activated if a message of category D is received (i.e. SAR, Mayday relay, Pirate attack etc.). The SAILOR 6390 Navtex Receiver is always on when powered. With its LAN interface the transponder and the display can be separated, giving access to the Navtex information available where it is needed.



The SAILOR 6390 Navtex Receiver is delivered as a black box receiver which can either be connected to the SAILOR 6004 Control Panel, a 7" touch screen, or used as a standalone unit for integration with an INS, supporting NMEA0183. A printer can be connected to the receiver.

The SAILOR 6390 Navtex Receiver is approved according to GMDSS (EU Marine Equipment Directive).

1. Default value.

Features

- 2000 messages per frequency, giving a total of 6000 messages
- Printing via SAILOR 6004 Control Panel and 3rd party line printer over LAN
- Integrated Navtex app for SAILOR 6004 Control Panel
- Low and high impedance antenna switch
- Dual LAN connector
- TMA (ThraneLINK Management Application) for software upgrade
- Prepared for 500 kHz NAVDAT (Software updatable)

Connector overview

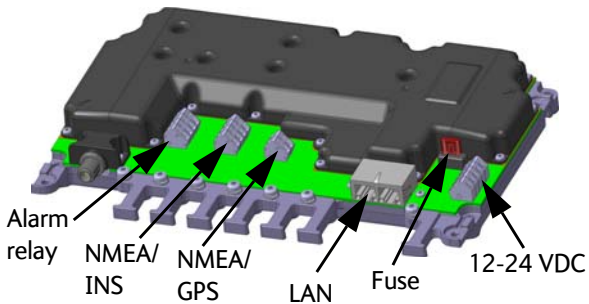

Navtex message (example)

The following message shows an example of a Navtex message.

```
ZCZC XZ28
REYKJAVIK VIA GRINDAVIK
120350 UTC SEPT 2013
```

```
NO MESSAGE ON HAND
NNNN
```

Message item	Explanation
ZCZC	Start of message (not displayed)
X	Coast Station ID in the Navigational Area
Z	Message type (See <i>The following list shows the Navtex message types available. on page 10</i> for a list of all message types.)
28	Serial number of message 01-99: (normal), 00: Priority
Message text	REYKJAVIK VIA GRINDAVIK 120350 UTC SEPT 2013 NO MESSAGE ON HAND
NNNN	End of message (not displayed)

Table 1: Navtex message, example

Use scenarios

The SAILOR 6390 Navtex Receiver can be used in the following contexts:

- *Use with the SAILOR 6004 Control panel*
- *Use as a stand-alone unit with an INS*

An optional printer can be connected in both use scenarios.

Use with the SAILOR 6004 Control panel

The SAILOR 6004 Control panel is the user interface for the SAILOR 6390 Navtex Receiver. The user interface is in English. All settings that are relevant for the user are accessed through the touch panel. Alarms and notifications are shown in the display and via NMEA. The SAILOR 6004 Control panel has a buzzer for alarm tones and the display supports night mode. The SAILOR 6390 Navtex Receiver has a Navtex application which is loaded into the SAILOR 6004 Control Panel during installation.



Use as a stand-alone unit with an INS

The SAILOR 6390 Navtex Receiver also works as a stand-alone unit, integrated in the vessel's INS. It supports the Navtex specific NMEA sentences according to the standard IEC 61097-6 and IEC 61162-1. For further details see the documentation of the INS.

Operation

This chapter has the following sections:

- *Operation – SAILOR 6004 Control Panel*
- *Operation with INS equipment*

Operation – SAILOR 6004 Control Panel

As soon as DC power is provided the SAILOR 6390 Navtex Receiver is on.

To switch on the SAILOR 6004 Control Panel push the power button. Operate the SAILOR 6004 Control Panel by tapping the touch screen. To switch off the SAILOR 6004 Control Panel push and hold the power button for 2 seconds and follow the instructions on the screen.



Note

When the remote switch in the SAILOR 6004 Control Panel is wired and it is switched on, you can only use the Power button to reboot the SAILOR 6004 Control Panel, you cannot switch it off.

To start the Navtex application tap the **Navtex** icon in the display of the SAILOR 6004 Control Panel.



The icon **System** holds the application manager and settings for the SAILOR 6004 Control panel, for more details see *Reinstalling or updating the Navtex app* on page 17.

Dim and night mode

Turn the dim knob of the SAILOR 6004 Control Panel to increase or decrease the display brightness. The display goes into **night mode** either when turning the dim knob counterclockwise or when the internal light sensor detects the light level for changing to night mode¹.



To dim to level zero push the power button once. If an alarm appears while the display is in level zero, the display returns to the latest dim value and the alarm is displayed.

Navtex screen

The Navtex app has the following idle screen:



1. Top bar



- Current app, in this case Navtex, showing the name of the SAILOR 6390 Navtex Receiver
- Icon for accessing the filters, settings and print options.

1. If dimming is set to AUTO.

2. Navtex app-specific area

Details	Id	Type	Time	Freq
	TA76	Nav warning	03:13	490
	SA73	Nav warning	03:04	518
	SA72	Nav warning	03:04	518
	PE55	Met forecast	02:33	518
	OJ38	GNSS	02:25	518
	OG19	AIS	02:24	518
	MAE1	Navigation	02:01	518

Short message listing, each row represents a Navtex message. Tap a message to display the full message.

- Open envelope: The message has been read or is older than 24 hours.
- Closed envelope: The message has not been read and is newer than 24 hours.

Only messages filtered for **Display** are shown in this list. For more information on filtering message types and stations see *Filtering message types and stations* on page 9.

3. Bottom bar

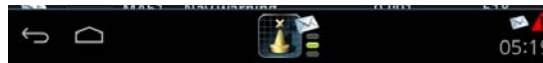

Receiving at 518 kHz

- Icon for back function and collapsing the on-screen keyboard.
- Icon for going to the start screen.
- Icon for app that is operated from this SAILOR 6004 Control Panel, including status information.
- Icons for new messages (closed envelope). After 24 hours messages are automatically set to not new (open envelope). Unread SAR messages are marked with a red exclamation mark.
- 3 indicators, from the top: 4209.5 kHz (local), 518 kHz (international, mandatory), 490 kHz (local). Green while receiving a message.
- Icon for alarms from any unit controlled by this SAILOR 6004 Control Panel:
 - Flashing bright red triangle: Unacknowledged alarm(s).
 - Faded red triangle: Acknowledged alarm(s).
- UTC time, received from the Navtex receiver via GPS input.

Sorting the list of Navtex messages

To sort the list of Navtex messages tap the heading of the column. Tap it again to toggle the sorting order, ascending or descending. The default sorting is for Time, newest on top.

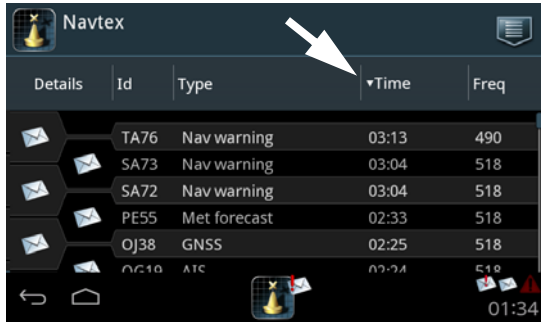

Navtex message in detail

To view details of a navtex message tap the message.

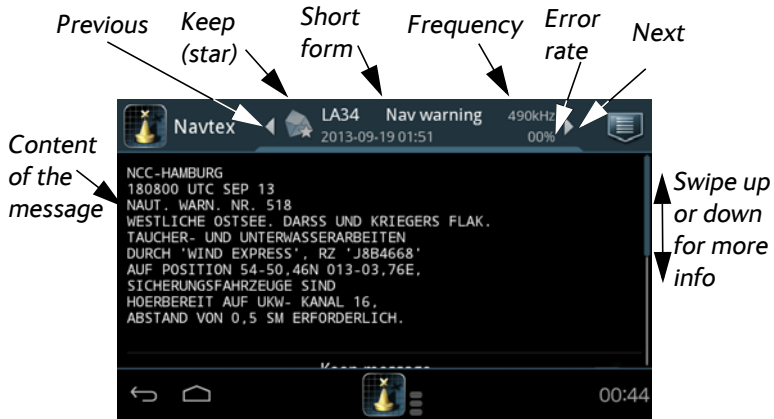

Swipe down, if needed, to select **Keep message**. Then the envelope icon for this message is marked with a star and the message is not automatically deleted after 66 hours¹.

To print a message, tap the menu icon and **Print**.

1. Default value.

SAR messages

When a SAR message (message type D, see page 9) is received, the SAILOR 6390 Navtex Receiver emits an audible signal and the message is displayed in the SAILOR 6004 Control Panel's display.

Tap the message to acknowledge it.

Filtering message types and stations

You can customise the SAILOR 6390 Navtex Receiver to receive Navtex messages of certain types and from selected coast stations. You can filter separately for printer output, SAILOR 6004 Control Panel (Display) and INS installations. You can set up a filter for each of the 3 receiver frequencies. The filters are not affected by a power cycle. Filter settings can be copied from one tab to the others, e.g. from **Display** to **Printer** or **INS**.

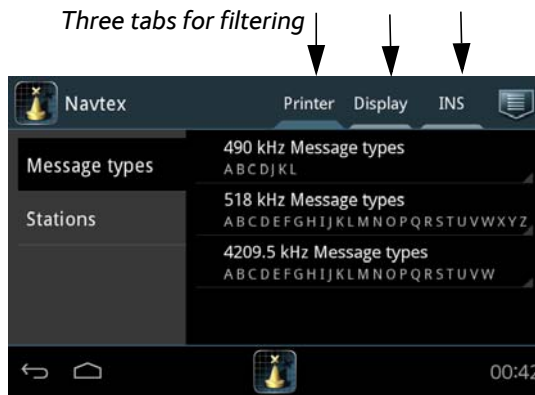

Filtering message types

To filter message types for a frequency do as follows:

1. Tap the menu icon and then **Filters**.
2. Tap **Printer**, **Display** or **INS** to select for which output you want to set up a filter.
3. Tap the frequency you want to set up a filter for, e.g. **490 kHz Message types**.

4. Swipe the field **Select message types** and select the message types you want to receive on this frequency. A, B, D and L are mandatory.
5. Tap **Apply**. The selected message types are displayed directly below the frequency.

The following list shows the Navtex message types available.

Note

Message types A, B, D and L cannot be filtered out.

- **A – Navigational warnings**
- **B – Meteorological warnings**
- C – Ice reports
- **D – Search and rescue information (SAR), acts of piracy warnings, tsunamis and other natural phenomena**
- E – Meteorological forecasts
- F – Pilot and VTS service messages
- G – AIS service messages (non navigational aid)
- H – LORAN messages (LONgRANgeNavigation)
- I – Reserved
- J – GNSS messages
- K – Other electronic navigational aid system messages
- **L – Other Navigational warnings**
- M,N,O,P,Q,R,S,T,U – Reserved
- V,W,X,Y – Special
- Z – No Message

Copying filter settings

To copy filter settings from one filter to another do as follows:

1. While in the **Filter** mode tap the menu icon.
2. Tap **Copy to...**
3. Tap the filter you want to copy to, e.g. from **Printer** to **Display** or **INS**.
4. Tap **Close**.

Filtering stations

The SAILOR 6390 Navtex Receiver can automatically filter messages from coast stations within a certain range of NM of own position (default). You can also filter coast stations manually.

For a list of stations see the Admiralty List of Radio Signals and ITU List of Coast stations and Special Service Stations (List IV) (<http://www.itu.int>).

To set up filters for stations do as follows:

1. Tap the menu icon and then **Filters**.
2. Tap **Printer**, **Display** or **INS** to select for which output you want to set up a filter.
3. For automatic filtering select **Automatic Mode**. Tap **Range**, select the wanted radius in Nautical Miles and tap **Apply**. The coast stations within this range are displayed.¹

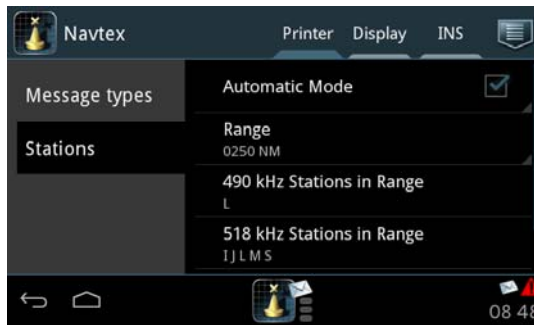

4. For manual selection, deselect **Automatic Mode** and tap the frequency you want to set up a filter for, e.g. **490 kHz Stations**. Swipe the field **Select stations**, select the stations you want to receive on this frequency and tap **Apply**. The selected stations are displayed directly below the frequency.

1. For Automatic Mode the SAILOR 6390 Navtex Receiver must have a valid GPS input. Without a valid GPS input you can only filter manually.

Printer attached to the SAILOR 6004 Control Panel

A printer can be connected to one of the USB connectors of the SAILOR 6004 Control Panel. Every time a Navtex message is received and applies to the filtering set up for **Printer**, the message is output on the printer.

The SAILOR 6390 Navtex Receiver applies header and footer information to the printout, stating frequency, date and time of reception and serial number of the SAILOR 6390 Navtex Receiver.

If the printed message line is longer than allowed on the printer, the printer inserts the sign ~ to indicate a forced line division and breaks the line.

Selecting print lists

To print a selected list do as follows:

1. From the list of messages, tap the menu icon and Print.
2. Tap the list you want to print.

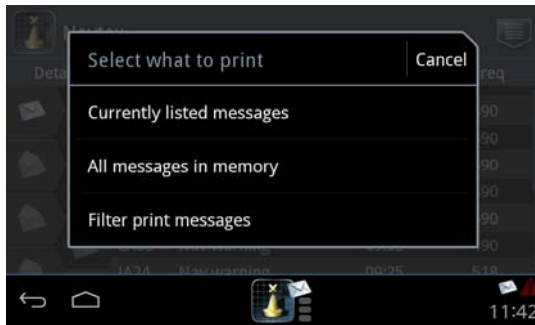

Operation with INS equipment

Messages filtered out using the INS filter settings are sent to the INS equipment via NMEA. See the user documentation for the INS for further information how Navtex messages are displayed and printed.

Service & maintenance

This chapter has the following sections:

- *Maintenance*
- *Alarms and notifications*
- *Reinstalling or updating the Navtex app*
- *Troubleshooting guide*
- *Service and repair*

Maintenance

Maintenance of the SAILOR 6390 Navtex Receiver can be reduced to a maintenance check at each visit of the service staff. Inspect the unit for mechanical damages, salt deposits, corrosion and any foreign material. Due to its robust construction and ruggedness the unit has a long lifetime. Anyway it must carefully be checked at intervals not longer than 12 months – dependent on the current working conditions.

Contact for support

Contact an authorized dealer for technical service and support of the SAILOR 6390 Navtex Receiver. Before contacting the authorized dealer you can go through the troubleshooting guide to solve some of the most common operational problems.

System LEDs

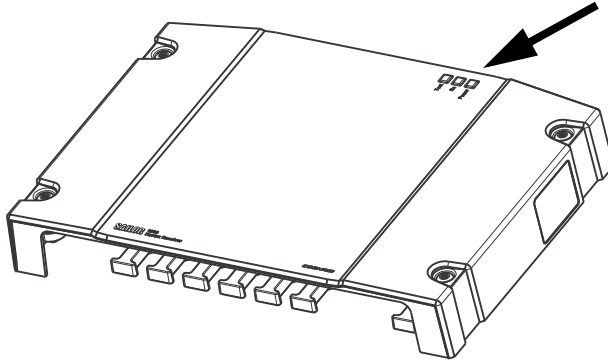

LED	Colour	Description
Power	Green	Lit when the device is on.
Rx	Green	Flashing when receiving Navtex data on any active frequency.
Test	Green	Lit when the power-on-self-test is passed. Flashes if a fault is detected.

Table 2: LEDs on the SAILOR 6390 Navtex Receiver

Alarms and notifications

Overview

If an alarm is reported from the SAILOR 6390 Navtex Receiver a flashing red triangle appears in the bottom bar of the SAILOR 6004 Control Panel display:

- Flashing, bright red triangle: Unacknowledged alarm(s).
- Faded red triangle: Acknowledged alarm(s).



To acknowledge an alarm do as follows:

1. Tap the flashing, bright red triangle to display the list with active alarms.
2. Tap the alarm to acknowledge the alarm.

When all active alarms are acknowledged the bright red triangle turns into a faded red triangle.

Alarms and notifications are either shown in the display of the SAILOR 6004 Control Panel or output via NMEA sentences and displayed in other equipment.

Installation with SAILOR 6004 Control Panel

Alarm	Description	Remedy
001	Navigational Warning	Read associated message.
002	Meteorological Warning	Read associated message.
003	Search and Rescue Information	Read associated message.
004	Receiver Malfunction	Contact your supplier.
005	Built-in Self Test Failure	Check antenna installation.
006	General Failure	Power cycle the unit. If this does not help, contact your supplier.
067	GNSS position lost	Check the GPS input.
068	Automatic mode disabled (no fix)	Check the GPS input. Without a valid GPS input the automatic mode does not work.

Table 3: Navtex alarms

If the connection between the SAILOR 6390 Navtex Receiver and the SAILOR 6004 Control Panel is lost, the SAILOR 6004 Control Panel shows an error “Connection lost”. Make sure that no one is connected to the SAILOR 6390 Navtex Receiver using the Service Interface.

Alarm	Description	Remedy
060	Printer is offline	Set online.
061	Printer is busy	Wait until current print job is finished.
062	Printer is low on paper	Insert more paper.
063	Printer is out of paper	Insert more paper.
064	Printer not connected	Check the printer connection. ^a
065	Printer error	See the original printer documentation.
066	No default printer configured	This must be set up during installation. Contact your installation centre.

Table 4: Navtex alarms, printer

- a. Alarm 064 is the only alarm output for 3rd party print servers.

Installation with an INS

Alarms and notifications are signalled via the NMEA sentence ALR. See the user documentation of the equipment connected to the SAILOR 6390 Navtex Receiver for further information on how alarms and notifications are displayed.

Example: \$CRALR,246060,002,A,V,NAVTEX: Meteorological Warning*09

CR = Navtex

ALR = alarm sentence

246060 = time (hours,minutes, seconds)¹

002 = alarm number (see Table 3 on page 16 and Table 4 on page 16)

A (A – active / V – not active)

V (A – confirmed / V – not confirmed)

NAVTEX: Meteorological Warning (text description)

*09 (checksum indicator and checksum)

Reinstalling or updating the Navtex app

The Navtex app is typically installed in the SAILOR 6004 Control Panel during installation. If you for one reason or another have to reinstall the app, read the following sections to familiarize yourself with the app of the SAILOR 6004 Control Panel and follow the instructions later in this section how to install the Navtex app.

System app

Having switched on the SAILOR 6004 Control Panel, an icon named **System** is always displayed, plus the icon(s) of the applications that are installed. Under **System** you can set up and manage the SAILOR 6004 Control Panel.

1. 246060 indicates unknown time (invalid time stamp), e.g. if there is no or invalid GPS input.



Tap the icon **System** and the following topics are available:

- *Settings* for Network settings, Date/Time and Debugging.
- *Applications* to install and manage applications.
- *Self Test* for testing Touch, Controls, Display, Audio, USB, Light Sensor, Alarm Output, NMEA and LAN.
- *About* with Legal information, software versions and network information.

Settings

The parameters in the section Settings are typically taken care of during installation.

Tap **Settings** to enter the section for network configuration, date and time setting and debugging. Tap the section you want to work with and explore the touch screen for each setting. To change a setting you must enter the password for user level (user) and tap **OK**.

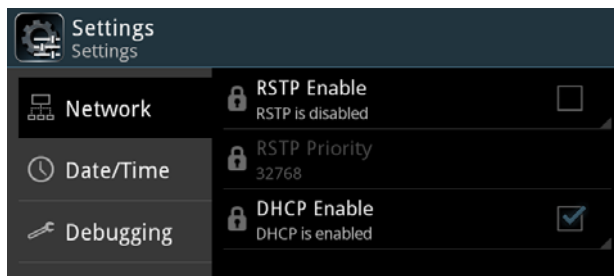

Applications

Tap **Applications** to install, uninstall or update applications. This section has two tabs: **Available**, showing the apps that are available to the SAILOR 6004 Control Panel on the current network, and **Installed**, showing the apps already installed.

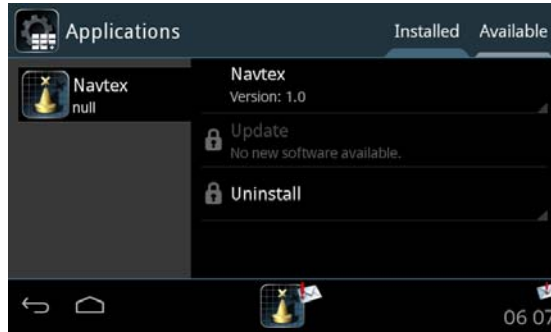

To install an app, do as follows:

1. Tap **Available** to display the apps that are available to this SAILOR 6004 Control Panel.
2. Tap the app you want to install.
 - Tap the app name, e.g. **Navtex** Version 1.0.
 - **Install** to install this app on the SAILOR 6004 Control Panel.
3. Enter the password for user level (user) and tap **OK**.

To manage an already installed app, do as follows:

1. Tap **Installed** to display the apps that are installed on this SAILOR 6004 Control Panel.
2. Tap the app you want to manage. For each app there are the following items:
 - App name and version, e.g. Navtex Version 1.0.
 - **Update** (if available, else grayed out) – tap here to update this app. Enter the password for user level and tap **OK**.

- **Uninstall** – tap here to uninstall this app from the SAILOR 6004 Control Panel.
3. Enter the password for user level (user) and tap **OK**.

Self Test

Tap **Self Test** to start the self test of the SAILOR 6004 Control Panel. For further details on the self test see the installation manual of the SAILOR 6004 Control Panel.

About

Tap **About** to view the following:

- **Legal** with legal and copyright information, open source licences, etc.
- **Version** with software versions and serial number of the SAILOR 6004 Control Panel.
- **Network** with IP address and MAC address of the SAILOR 6004 Control Panel.

Setting device names

The parameters in this section are typically taken care of during installation.

Important

If you change the ID for the SAILOR 6390 Navtex Receiver make sure that the ID in the SAILOR 6390 Navtex Receiver matches the ID in the SAILOR 6390 Navtex Receiver app displayed in the SAILOR 6004 Control Panel. Consult your installation centre.

To access this screen tap the menu icon and then **Settings**.

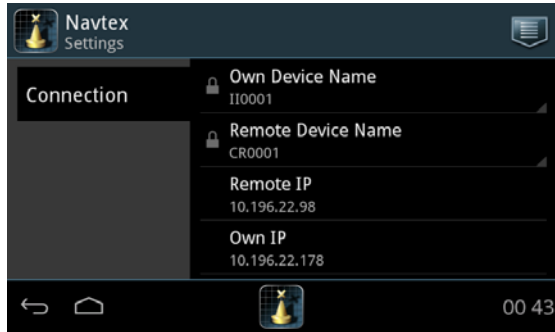

- **Own Device Name:** Identification of the SAILOR 6004 Control Panel in the network. It must consist of the letters II followed directly by 4 digits.
- **Remote Device Name:** Identification of the SAILOR 6390 Navtex Receiver in the network. It must consist of the letters CR followed directly by 4 digits. **This must be the same ID that has been programmed into the SAILOR 6390 Navtex Receiver during installation.**

If you need to change a parameter do as follows:

1. Tap the parameter and enter the password (user) and tap **OK**.
2. Enter the new data and tap **Apply**.

The ID is now changed in the SAILOR 6390 Navtex Receiver app, but not in the SAILOR 6390 Navtex Receiver unit. Use the **Back** icon to return to the idle screen. When you leave the page, the parameters are locked again.

Troubleshooting guide

Problem	Symptom	Remedy
The SAILOR 6390 Navtex Receiver will not turn on.	Green power LED on SAILOR 6390 Navtex Receiver is off.	If the power cable is connected directly to the SAILOR 6390 Navtex Receiver then check that ON IN is wired to VBAT-.
No message can be received.	Test LED flashes.	Check the antenna installation.
The Time column shows dashes, but not time	No valid message time.	Check the GPS connection.
Device failure		If any of the checks and tests described in this section do not assist in resolving the difficulties experienced in the operation and/or performance of the Navtex installation, a fault may have developed. When contacting an authorized representative be sure to provide as much information as possible describing the observed behaviour - also including the type of the Navtex units, serial number, and software release version. You find this information in the setup menu of the connected SAILOR 6004 Control Panel.

Table 5: Troubleshooting guide

Problem	Symptom	Remedy
SAILOR 6004 Control Panel cannot be switched off.		If the SAILOR 6004 Control Panel cannot be switched off normally (e.g. due to a fault): Push and hold for 12 seconds. If a remote switch is installed, see the note on page 5.
Password entered in the SAILOR 6004 Control Panel, but padlock does not open	Authorization failed. Wrong password or the connection to the SAILOR 6390 Navtex Receiver is lost	Check that you enter the correct password. Check the power supplies, cabling, Ethernet connection between the SAILOR 6390 Navtex Receiver and the SAILOR 6004 Control Panel. Restart both units: – SAILOR 6390 Navtex Receiver: remove and connect power, – SAILOR 6004 Control Panel: use on/off button. Password for SAILOR 6004 Control Panel: user
RX self test failed		Check the antenna installation.

Table 5: Troubleshooting guide (Continued)

RX self test (with SAILOR 6004 Control Panel)

The RX self test runs automatically after start-up. You can also manually start an RX self test.

1. From the idle screen, tap the menu icon in the upper right corner.
2. Tap **Settings**.
3. Tap the menu icon and tap **RX self test**.
4. Tap **Yes** to start the RX self test. The result of the test is shown in the display. If the test has failed check the antenna installation.
If a printer is connected and enabled the self test results are printed.

Service and repair

Should your Cobham SATCOM product fail, please contact your dealer or installer, or the nearest Cobham SATCOM partner. You will find the partner details on www.cobham.com/satcom where you also find the Cobham SATCOM Self Service Center web-portal, which may help you solve the problem.

Your dealer, installer or Cobham SATCOM partner will assist you whether the need is user training, technical support, arranging on-site repair or sending the product for repair.

Your dealer, installer or Cobham SATCOM partner will also take care of any warranty issue.

Applicable SAILOR part numbers

Part number	Description
406390A-00500	SAILOR 6390 Navtex Receiver
406391A-00500	SAILOR 6391 Navtex System (SAILOR 6004 Control Panel and SAILOR 6390 Navtex Receiver)
406004A-00500	SAILOR 6004 Control Panel

Table 6: Part numbers

Disassembling – removing the cover

1. Remove the cover of the SAILOR 6390 Navtex Receiver by loosening the 4 screws marked in the figure below.

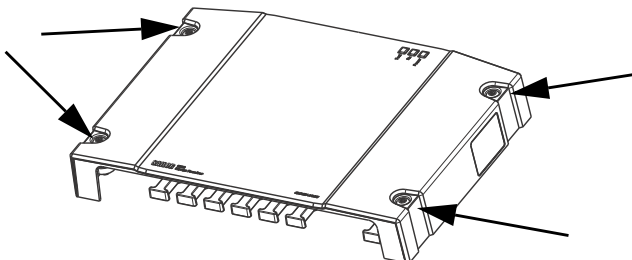

2. Remove the cables from the spring-loaded terminals and the connectors.
3. Remove the SAILOR 6390 Navtex Receiver by moving it upwards, away from the mounting surface.

Replacing the fuse

One fuse is installed in the SAILOR 6390 Navtex Receiver. If this fuse is blown, do as follows:

1. Track down why the fuse was blown and solve the problem, e.g. incorrect polarity at the DC supply.
2. Remove the cover by loosening the 4 screws.
3. Take out the old fuse. Use the fuse puller.
4. Insert the new fuse. The fuse rating is 1 A.

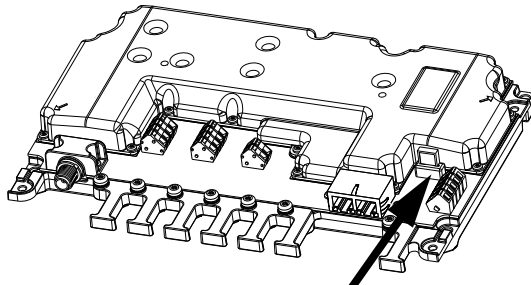

Repacking for shipment

Should you need to send the product for repair, please read the below information before packing the product.

The shipping carton has been carefully designed to protect the SAILOR 6390 Navtex Receiver and its accessories during shipment. This carton and its associated packing material should be used when repacking for shipment. Attach a tag indicating the type of service required, return

address, part number and full serial number. Mark the carton FRAGILE to ensure careful handling.

Note | Correct shipment is the customer's own responsibility.

If the original shipping carton is not available, the following general instructions should be used for repacking with commercially available material.

1. Wrap the defective unit in heavy paper or plastic. Attach a tag indicating the type of service required, return address, part number and full serial number.
2. Use a strong shipping container, e.g. a double walled carton.
3. Protect the front- and rear panel with cardboard and insert a layer of shock-absorbing material between all surfaces of the equipment and the sides of the container.
4. Seal the shipping container securely.
5. Mark the shipping container FRAGILE to ensure careful handling.

Failure to do so may invalidate the warranty.

Disposal

Old electrical and electronic equipment marked with this symbol can contain substances hazardous to human beings and the environment. Never dispose these items together with unsorted municipal waste (household waste). In order to protect the environment and ensure the correct recycling of old equipment as well as the re-utilization of individual components, use either public collection or private collection by the local distributor of old electrical and electronic equipment marked with this symbol.



Contact the local distributor for information about what type of return system to use.

Specifications

SAILOR 6390 Navtex Receiver

Item	Specification
Weight	1.3 kg
Dimensions	L x W x H: 190 x 270 x 42.5 mm
Input voltage	12-24 VDC (10.8 VDC to 31.2 VDC)
Power consumption	Typical 6.5 W
Heat dissipation	<10 W
Temperature	-15 °C to +55 °C (Operational) -15 °C to +55 °C (Storage)
Compass Safe Distance	20 cm (Standard magnetic compass) 20 cm (Emergency magnetic compass)
IP rating	IP22 (estimated)
Navtex receivers	490 kHz, 518 kHz and 4209.5 kHz simultaneous reception. Software updatable for 500 kHz NAVDAT
Antenna support	Active and passive antenna (12 V @ 60 mA antenna supply)
Sensitivity 490/518 kHz	<12 dB μ V@10 Ω /150 pF <-6 dB μ V@50 Ω
4209.5 kHz:	<12 dB μ V@10 Ω /150 pF <6 dB μ V@50 Ω

Table 7: SAILOR 6390 Navtex Receiver specifications

Item	Specification
Interfaces	TNC antenna connector Alarm relay output (normally closed) 2 LAN connectors Remote on NMEA0183 in and out for INS support NMEA0183 in for e.g. GPS input 600 Ω single ended audio interface for troubleshooting
Printer	Support via LAN connector
NMEA sentences	NMEA0183 input, EN61162-1: ACK, NRM, CRQ sentences NMEA0183 output, EN61162-1: ALR, NRM, NRX sentences GPS input: RMC, ZDA sentences Proprietary sentences

Table 7: SAILOR 6390 Navtex Receiver specifications (Continued)

A

AIS Automatic Identification System. Automatic tracking system used on ships and by vessel traffic services (VTS) for identifying and locating vessels by electronically exchanging data with other nearby ships and AIS Base stations.

G

GMDSS Global Maritime Distress and Safety System. The system is intended to perform the following functions: alerting (including position determination of the unit in distress), search and rescue coordination, locating (homing), maritime safety information broadcasts, general communication, and bridge-to-bridge communication.

GNSS Global Navigation Satellite System

GPL General Public License, software license, which guarantees individuals, organizations and companies the freedom to use, study, share (copy), and modify the software.

GPS Global Positioning System

I

INS Integrated Navigation System

L

LAN Local Area Network

LGPL Lesser General Public License

LORAN LOng RAnge Navigation, a terrestrial radio navigation system which enables ships and aircraft to determine their position and speed from low frequency radio signals transmitted by fixed land based radio beacons.

N

NAVDAT High Speed NAVtex DATa sent out on 500 kHz. Not yet part of mandatory Navtex reception, but mentioned in ITU-R M.2010 and ITU-R M.2201.

NMEA National Marine Electronics Association (standard). A combined electrical and data specification for communication between marine electronic devices such as echo sounder, sonars, anemometer (wind speed and direction), gyrocompass, autopilot, GPS receivers and many other types of instruments. It has been defined by, and is controlled by, the U.S.-based National Marine Electronics Association.

S

SAR Search And Rescue

U

UTC Universal Time, Coordinated. The International Atomic Time (TAI) with leap seconds added at irregular intervals to compensate for the Earth's slowing rotation. Leap seconds are used to allow UTC to closely track UT1, which is mean solar time at the Royal Observatory, Greenwich.

A

- alarm, 15
 - acknowledge, 15
 - icons, 7
- alarms
 - INS, 17
 - Navtex, 16
 - printer, 16
- app
 - install, 19
 - start Navtex, 5
 - uninstall, 19
 - update, 19
- applications, 18, 19
- approvals, iv
- automatic mode, 11

B

- brightness, 6
- buzzer, 4

C

- coast station
 - filtering, 11
- collapse keyboard, 7
- compass safe distance, iii
- contact
 - support, 13
- copy
 - filter settings, 10

D

- device names, 20
- dimming function, 6
- disassembling, 24
- display
 - brightness, 6
- document number
 - this manual, i

E

- error rate, 8

F

- features, 2
- filter settings
 - copy, 10
 - message types, 9
 - stations, 11
- filtering
 - message types, 9
 - stations, 11
- frequencies
 - receiver, 7
- fuse
 - rating Navtex Receiver, 25
 - replace Navtex Receiver, 25

I

- ID
 - Control Panel, 21
 - Navtex Receiver, 20, 21
- idle screen, 6
- install app, 18, 19
- invalid time stamp
 - alarm, 17
- IP address
 - Control Panel, 20
 - Navtex Receiver, 21

K

- keyboard
 - collapse, 7

L

- LED
 - Power, 14
 - Rx, 14
 - Tx, 14
- license
 - software, ii

M

- MAC address
 - Control Panel, 20

maintenance, 13
manual
 document number, i
message
 keep, 8
message types, 10
 filtering, 9

N

NAVDAT, 2
Navtex app
 overview, 6
 reinstalling, 17
Navtex application
 start, 5
Navtex frequencies, 1
Navtex message
 detail, 8
 example, 3
 keep, 8
Navtex Receiver
 remove lid, 24
 specifications, 27
 use stand alone, 4
 use with Control panel, 4
night mode, 4, 6

O

open source licences, 20

P

part numbers, 24
password, 19
Power LED, 14
power on, 5
print lists, 12
printer, 12

R

receiver frequencies, 7
reinstall
 Navtex app, 17
remove lid of Navtex, 24

RF exposure, iii
Rx LED, 14
RX self test
 Navtex Receiver, 23

S

SAR message, 9
self test, 20
 Control Panel, 20
 Navtex Receiver, 23
settings, icon, 6
software
 license, ii
 uninstall, 19, 20
sorting messages, 8
specifications
 Navtex Receiver, 27
standard compliance, iv
stations
 filtering, 11
support
 contact info, 13
switch on, 5

T

time
 invalid, 17
troubleshooting, 22
Tx LED, 14

U

uninstall, 19, 20
update
 Navtex app, 17
use scenario
 stand alone, 4
 with Control Panel, 4
UTC time, 7

W

warranty, iii, 24